



omsacorpress

SOLUCIONES RÁPIDAS EN BIENES Y SERVICIOS

SILLONES DE OFICINA



ERGONOMICOS



GERENCIALES



SECRETARIAS

SILLAS DE ESPERA



TANDEM



VISITAFIJA



SOFAS PERA

ACCESORIOS Y REPUESTOS



NEUMÁTICOS



BASESILLON



SEPARADORES

SERVICIOS EN GENERAL



MOBILIARIO



FABRICACIÓN



RETAPIZADOS

CATÁLOGO DE PRODUCTOS



omsacorpxpress

SOLUCIONES RÁPIDAS EN BIENES Y SERVICIOS

*Estimados Señores,
Presente. -*

Por medio de esta carta, les saludo cordialmente y me presento ante ustedes para exponerle los bienes y servicios de nuestra empresa OMSACORP XPRESS.

OMSACORP XPRESS es una empresa especializada en la producción y comercialización de bienes y servicios de mejor calidad del país y con mayor preferencia por parte de las empresas a nivel nacional.

Es una empresa con muchos años de experiencia en el sector público y privado, pero siempre capacitándonos y modernizándonos, razón por la cual hoy les ofrecemos una nueva y mejorada presentación de bienes y servicios.

En caso de que esté interesado en nuestros bienes y servicios, no dude en contactarse con nosotros para poderles brindar información, asesoría y cotización de los bienes y servicios que ustedes requieran. Sin otro particular, me despido de ustedes no sin antes agradecerles por la atención brindada a esta carta.

Atentamente:

**GIOVANNY SALGUERO
GERENTE PROPIETARIO
OMSACORP XPRESS**



omsacorp xpress

SOLUCIONES RÁPIDAS EN BIENES Y SERVICIOS

NUESTRA MISIÓN

La misión de **OMSACORP XPRESS**, es la de suministrar bienes y proveer servicios a nivel nacional a todos nuestros clientes, en forma eficiente, económica y con productos de la mejor calidad, ajustándose a sus necesidades, siempre en beneficio del menor costo y con mayor satisfacción de los usuarios finales.

Estamos seguros que como empresa, **OMSACORP XPRESS** logrará suministrar bienes y proveer servicios a los clientes que se ajuste a sus necesidades y que rinda satisfactoriamente, además de que nuestros productos son de calidad y garantizados.

NUESTRA VISIÓN

La visión de **OMSACORP XPRESS**, es que los bienes y servicios lleguen a todos los clientes, ajustando nuestros productos a las necesidades y cuidando del bolsillo de los clientes suministrando bienes y proveer servicios de bajo costo en el mercado nacional.

En nuestra visión, también tenemos la de ocupar los sitios más preponderantes en el país suministrando bienes y proveyendo servicios a nivel nacional.

NUESTROS VALORES

En **OMSACORP XPRESS** valoramos a las personas y a los empleados, tenemos prioridad en el cuidado de los derechos de los empleados, sus familias, buscamos los mejores beneficios y satisfacción de los clientes y aseguramos el valor del planeta, usando productos que no produzcan daño en su uso y manufacturación al planeta, buscamos principalmente una conciencia inclusiva y también real, usando la tecnología para el beneficio de la sociedad y del propio planeta.

OMSACORP XPRESS está apegado a las leyes, inclusión social y dinamización de la economía del país, por lo cual la mayoría de nuestros bienes y servicios tienen agregado nacional, de esta manera fomentamos la mano de obra nacional, contamos con infraestructura adecuada y con personal técnico calificado, para suministrar bienes y proveer servicios, de esta manera damos trabajo a los ecuatorianos en beneficio de su economía y bienestar para su familia.



omsacorpress

SOLUCIONES RÁPIDAS EN BIENES Y SERVICIOS

SILLONES DE OFICINA

CARACTERÍSTICAS

- *Brazos 3D Regulables.*
- *Mecanismo Syncro 4 Bloqueos Antishock-Slider.*
- *Base Metálica de 70cm.*
- *Garruchas Nylon de 60mm.*
- *UP - DOWN Espaldar.*
- *Apoya Cabezas en Malla Regulable.*
- *Asiento y Espaldar en Malla.*
- *Posición Basculante.*

NOTA

- *Modelos Sujetos a Cambios sin Previo Aviso.*
- *Colores Disponibles solo los de la Foto.*
- *Disponibilidad de Modelos según Stock.*
- *Garantía de los Sillones 1 año.*
- *Sillones Importados.*

SILLONES ERGONÓMICOS



NILO H-9699F-1-2



FUSION KB-8903AS



FABIO MF-5013-A-1-ADJ



KANSAS MF-5013A-1



HC-808A BLA CK ERGOMESH



HC-4028A MALLA



KANSAS MF-5013A-1



SUPER RECLIN MF-6031



LONDON ERGOMESH



GEM EREGOMESH

SILLONES PRESIDENTE



MADONNA KB-8905A



LIVIO KB-8911A



LAMBO HZ-3336



MARCO A MF-3339A-N



BENETY ALTO MF-6122A



OPTIMA ADJ MF-6051B



LEXUS ALTO HZ-6606A-CR



LEXUS ALTO HZ-6606A-NY



HC-109-1 BLACK/BLACK



HC-109-2 BLACK/WHITE



HC-1193 CABEZAL



HC-117-2 CABEZAL

IMAGENES REFERENCIALES

SILLONES PRESIDENTE



HC-802A BLACK



LIVIO KB-8911A



HC-810A BLACK



SLIM PRESIDENTE



QUATRO PRESIDENTE



DONNA PRESIDENTE



WINNER PRESIDENTE



KIND PRESIDENTE



APOLO PRESIDENTE



LAREDO PRESIDENTE



BREMEN PRESIDENTE



SEUL PRESIDENTE

IMAGENES REFERENCIALES

SILLONES PRESIDENTE



SEDIA PRESIDENTE



BOSS PRESIDENTE



DOMUS PRESIDENTE



DRACO PRESIDENTE



SHINNY PRESIDENTE



CUZCO PRESIDENTE



YORKI PRESIDENTE



CITY PRESIDENTE



MEGAN PRESIDENTE



TUCSON PRESIDENTE



ALEMANIA PRESIDENTE



BASIC PRESIDENTE

SILLONES GERENTE



T-46Y



MARKO B MF-3339-CR



STUDIO H-935L-2



ITON BAJO-PU D-101



MF-8007 MADERA



PARIS MF-9909 MADERA



MF-8015 MADERA



EMPORIO DY-8842 MADERA



BENETY BAJO MF-6122B



JIUTA HZ-6120



FELIX D-409-1



OPTIMA MF-6051B

SILLONES GERENTE



RENO D-422



CLASS KB-9652



MASTER DY-8039



KING MF-6008



BACO MF-6009



SIRO D-419



NOA KB-9615A



MEGAN KB-9604B



PALACE ALTO HZ-3019A



LEXUS BAJO HZ-6606B-CR



LUXUS BAJO HZ-6606B-NY



LEXUS BAJO HZ-6606C-NY

IMAGENES REFERENCIALES



HC-249-1 BLACK



HC-249-1 BROWN



HC-268



HC-213



HC-259



HC-6003



HC-241



HC-206-1



HC-121-1 BLACK



HC-2004H



HC-2004M



HC-2043B

SILLONES GERENTE



HC-2043



HC-1794



HC-2031



HC-1693H



HC-2052H



HC-1687B



HC-611 BLACK



HC-6019M BLACK



HC-8101M



HC-801B MALLA/TELA



HC-802B BLACK



NORUEGA GERENTE

SILLONES GERENTE



SLIM GERENTE



QUATRO GERENTE



DONNA GERENTE



WINNER GERENTE



KIND GERENTE



VERSALLES GERENTE



DUBAI GERENTE



SEDIA GERENTE



DOMUS GERENTE



CUZCO GERENTE



CAMRY GERENTE



MEGAN GERENTE

SILLONES GERENTE



MARK GERENTE



JOY GERENTE

SILLONES GAMMER



GAMMER D-9403 ROJO



GAMMER D-9403 AZUL



RALLY D-301E2 NARANJA



RALLY D-301F7 AMARILLO



RALLY D-301F4 AZUL



RALLY D-301A4 ROJO



GAMMER HC-R-10

SILLAS SECRETARIA



CADIZ MF-5028



NAPOLI DE-5019CR



TURIN DE-3330-CR



ANNA H-8078F-5



GEOCONDA KB-20160



SIENA DE-3017



MF-3038 NEGRA



MALIBU KB-2017



ECO H-8522



LEE DY-6034



GENIO MC-301



PALACE BAJO HZ-3019B



HC-121-1



HC-113



HC-123



HC-111



HC-122



HC-118



HC-133



HC-628-A BLACK



HC-625 BLACK



HC-6144



HC-6013 BLACK



HC-6014M

SILLAS SECRETARIA



HC-6045B



HC-352



HC-6090M



HC-6072-1 MALLA/TELA



HC-6055B



HC-6055A



HC-95B BLACK



HC-848 BLACK



HC-4040 BLACK



VENUS



TORINO



ONIX

SILLAS SECRETARIA



STAY



DELPHI



DELPHI 2



BILL



BINGO



THINK



STUHL



MUK



SIAM



HOLANDA



LOGAN



FONE

SILLAS SECRETARIA



PRAGA



JAZZ



HADES



IRLANDA



URON



CRONOS



PEKIN



MALBA PLASTICA



BUTTERFLY LPT



MALIBU



MALI



ATLANTIS



BUTTERFLY PLASTICA



MOVIE



TAMPA



ORION ECO PLASTICA



PRISMA



EON



RUDY ALTA



RUDY MEDIA



PILOT

TAPIZADO: Tela o Corrosil.

Colores a Elejir.

Opción Base Metálica Cromada.

Opción Base Plástica Nylon.

Opción Con o Sin Brazos.

TAPIZADO: Tela o Corrosil.

Colores a Elejir.

Opción Base Metálica Cromada.

Opción Base Plástica Nylon.

Opción Con o Sin Brazos.

SILLAS CAJERA



ANNA CAJERA H-8078F-5



ECO CAJERA H-8522



PILOT CAJERA



FOCUS CAJERA



RUDY ALTA CAJERA

*TAPIZADO: Tela o Corrosil.
Colores a Elejír.*

*Opción Base Metálica
Cromada.*

*Opción Base Plástica
Nylon.*

*Opción Con o Sin Brazos.
Aro Cromado o Plástico.*

*TAPIZADO: Tela o Corrosil.
Colores a Elejír.*

*Opción Base Metálica
Cromada.*

*Opción Base Plástica
Nylon.*

*Opción Con o Sin Brazos.
Aro Cromado o Plástico.*

*TAPIZADO: Tela o Corrosil.
Colores a Elejír.*

*Opción Base Metálica
Cromada.*

*Opción Base Plástica
Nylon.*

*Opción Con o Sin Brazos.
Aro Cromado o Plástico.*

SILLAS DE ESPERA



ANNA H-8078F-5L



MONACO H-9088L-3



CITY BY-6008C



B-46Y



ITON PU D-101L



YMG-9208C-1



YMG-9210T-1



YMG-9110A-1



YMG-9108A-1



YMG-9308A-2



YMG-9120C



YMG-9120A-1

IMAGENES REFERENCIALES

SILLAS DE ESPERA



YMG-9105



YMG-9102-1



YMG-9302A



YMG-9905



YMG-BP9110C



YMG-9705A-1



YMG-9719A-1



YMG-9710A-1



YMG-9719



YMG-9720A-1



YMG-9502-1



YMG-9708A-1



SILLAS DE ESPERA



HC-2004V



HC-1687V



HC-611G-1



HC-352G



HC-6031G



HC-334



HC-8201L



KAMIL K02



KAMIL 588



KAMIL 588-5C



KAMIL 599-7



KAMIL 566



SILLAS DE ESPERA



KAMIL 194Q



KAMIL 194W



KAMIL 177L



KAMIL 194L



KAMIL 179M



KAMIL 178H



KAMIL 116



HC-802C BLACK



CINDY 817B



CINDY 76



CINDY 820



CINDY 818

IMAGENES REFERENCIALES

SILLAS DE ESPERA



HC-4028C



HC-2020BLACK



APOLO



ALEMANIA



YORKY



NEO



ISO-NET LPT



ISIS



PINKO



SOFT



ISO PU



DELPHI 2

SILLAS DE ESPERA



MALI



PISSA



SOFT TAPIZ II



ISO MALLA INTER



ISO MALLA



UKA



VIVA



PLEGABLE



MALBA



MOVIE



BRENDA



LOFT

SILLAS DE ESPERA



JUNIOR



BUTTERFLY LPT



BUTTERFLY



ORION



PRISMA



MAUI



HIMALAYA



BALI



EAMES



EMA TAPIZ



RIVER



VIENTO

SILLAS DE ESPERA



AMBAR



EAMES C/B



EMA

TANDEMS



AEROPUERTO

FULL TAPIZ (2P-3P-4P)



AEROPUERTO

SEMI TAPIZ (2P-3P-4P)



AEROPUERTO

SIN TAPIZ (2P-3P-4P)



PRISMA (2P-3P-4P)



MOVIE (2P-3P-4P)



BUTTERFLY (2P-3P-4P)



ORION (2P-3P-4P)



GRAFFITY (2P-3P-4P)



TAMPA (2P-3P-4P)

IMAGENES REFERENCIALES

SOFAS



EAMES MECEDORA



RELAX RECLINABLE



MOON GIRATORIO



BARCELONA



CANCILLER (1P-2P-3P)



SOFA CAMA



YMG-9819D-1



YMG-9705B-1



YMG-9210G-1

TABURETES



YMG-9805-1



YMG-9802-1



YMG-9102G



YMG-8316B-1C



YMG-8116A-1



YMG-8115A-1



YMG-8817-1



YMG-8815-1



KAMIL 237D



HC-BAR STOOL



AIR



AIR 2



ROYAL



LUXOR



KIEL



TABURETES



BRAND



TRIBECA



TRIBECA CAJERA



POP



ASTER



WORK CON ESPALDAR



WORK SIN ESPALDAR

GUARDERIA



GUARDERIA

PUPITRE



FOLDY

MESAS FIJAS Y REGULABLES

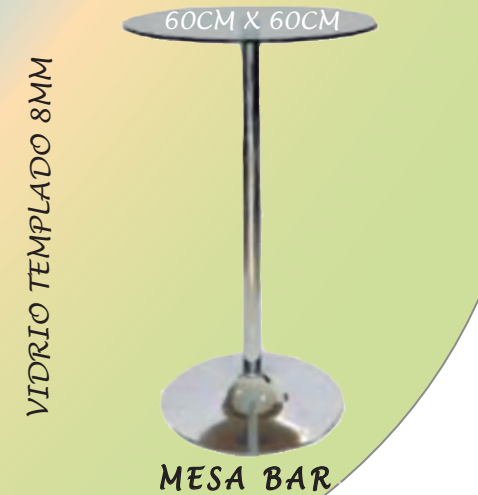
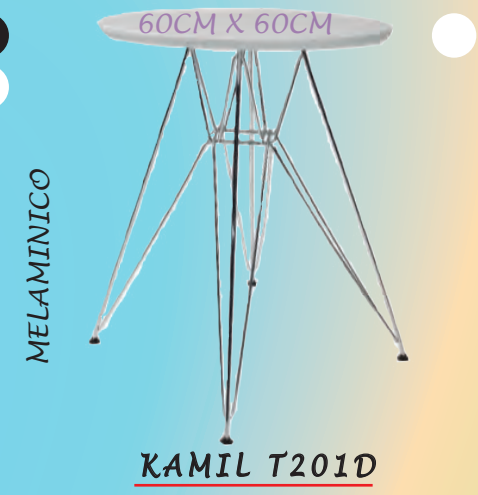
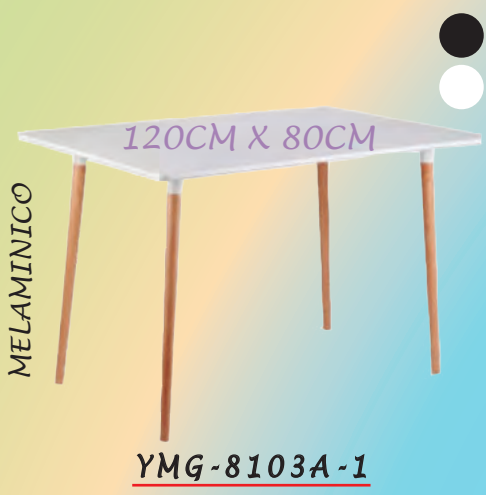
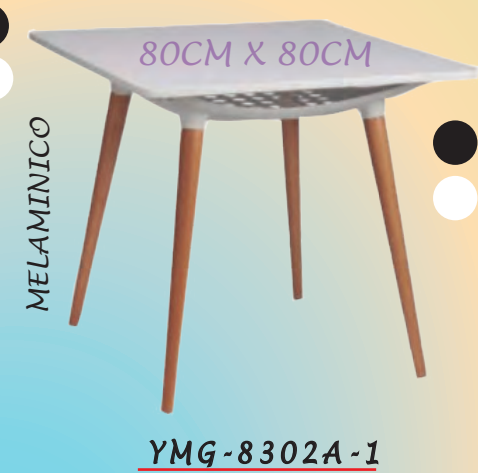

MESAS FIJAS Y REGULABLES

VIDRIO TEMPLADO

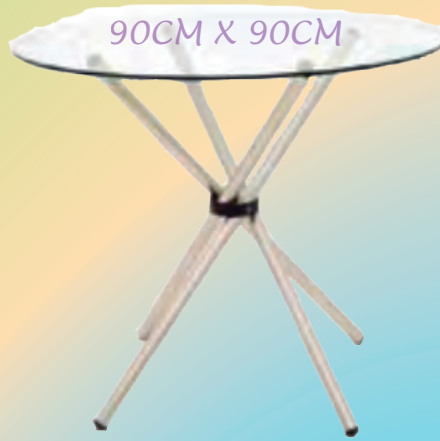

NODOS

BUTACAS AUDITORIO



CON PALA DE ESCRITURA



SIN PALA DE ESCRITURA



PARA TAPIZAR

ACCESORIOS Y REPUESTOS



BASE GERENTE NYLON



BASE GERENTE CROMADA



BASE SECRETARIA REC.



BASE SECRETARIA FIJA



BASE CAJERA NYLON



BASE CAJERA CROMADA



ARO CROMADO



ARO NYLON



DELPHI REGULABLE 3D



I9



09 REGULABLE



I9 SECRETARIA



35



35 ECO



38



207



MADAME



I5



EUFORIA



BUTTERFLY



TAMPA



ORION ATLANTA



GARRUCHA PISO DURO



GARRUCHA EUROPA



NIVELADOR FIJO



GARRUCHA NYLON

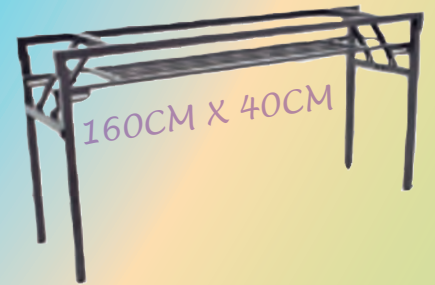

ESTRUCUTRA MESA PLEG.

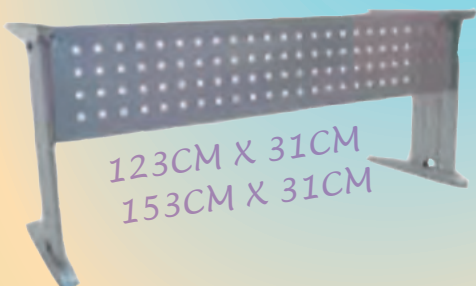

FALDON



SEPARADOR DE FILA



BASE PLATAFORMA

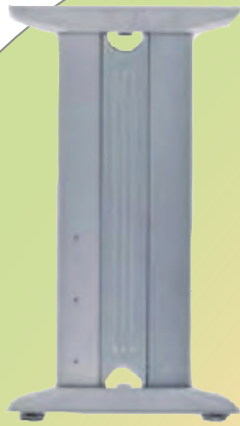

SOPORTE I



SOPORTE C



NEUMATICO SECRETARIA



NEUMATICO GERENTE



NEUMATICO CAJERO



TUBO ADAPTADOR

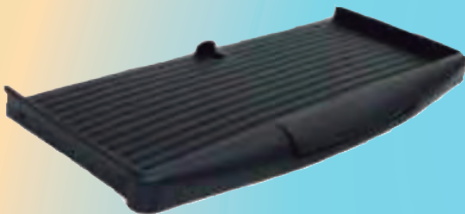

PORTA TECLADO

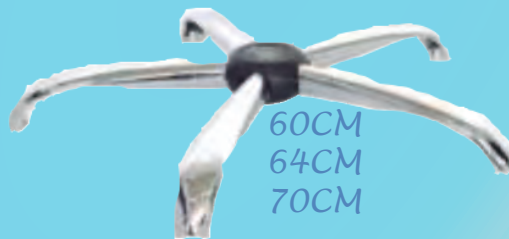

60CM
64CM
70CM

ARAÑA CROMADA



60CM
64CM
70CM

ARAÑA ALUMINIO

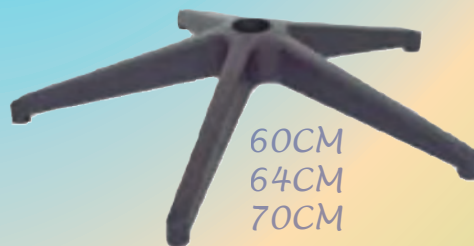

60CM
64CM
70CM

ARAÑA NYLON

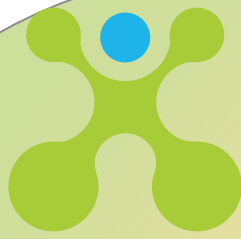

omsacorpress

SOLUCIONES RÁPIDAS EN BIENES Y SERVICIOS

MOBILIARIO EN GENERAL

CARACTERÍSTICAS

- *Fabricación de Mobiliario de Oficina, Bancario, Escolar y Médico.*
- *Fabricación de Sillones Tapizados en Tela o Corosil.*
- *Mobiliario en Melamínico o Formica.*
- *Estructura Metálica en Pintura Electroestática o Cromada.*
- *Mobiliario Bajo Diseño.*
- *Medidas y Colores a Elegir.*
- *Servicio de Arreglo de Mubles.*
- *Servicio de Retapizado.*
- *Garantía de 1 Año.*



QHAPAX



QHAPAX VISITA



CHUKUY



TIYAKUY



SILLA DE VISITA

ESCRITORIOS EN L



JATUM 1



MODELO 1



JATUM 2

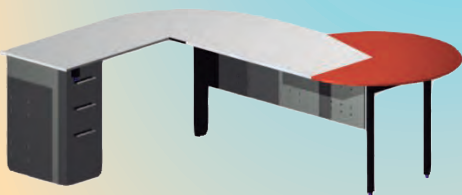

MAKIPURA HPL



MAKIPURA VIDRIO



MODELO 2

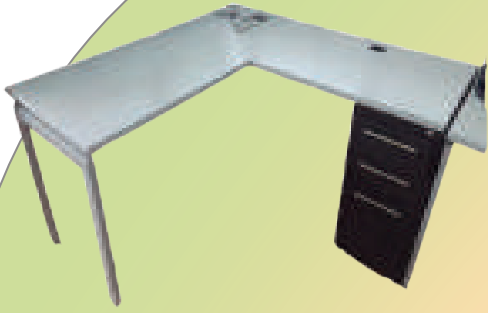

MINKA 1



MINKA 1 S-C



MODELO 3



MODELO 4



MODELO 5



MODELO 6



MODELO 7



MODELO 8

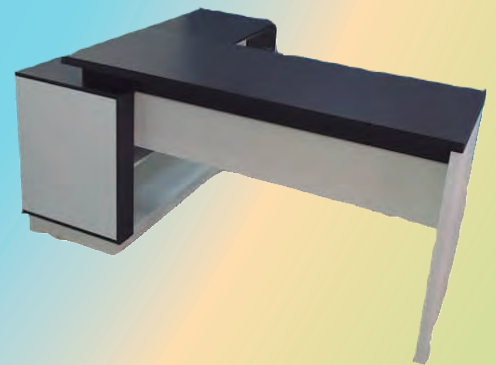

MODELO 9



MODELO 10



MODELO 11



MODELO 12



MODELO 13



MODELO 14



MODELO 15



MODELO 16



MODELO 17



MODELO 18



MODELO 19



MODELO 20



MODELO 21



MODELO 22



MODELO 23



MODELO 24



MODELO 25



MODELO 26



MODELO 27



MODELO 28

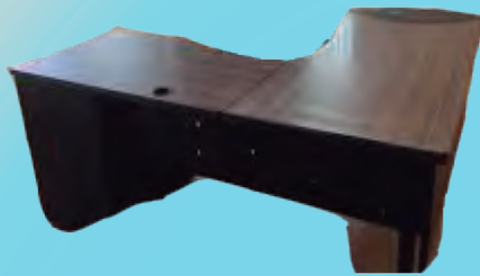

MODELO 29



MODELO 30



MODELO 31



MODELO 32



MODELO 33



MODELO 34



MODELO 35

ESCRITORIOS RECTOS



MODELO 1



MODELO 2



MODELO 3



MODELO 4



MODELO 5



MODELO 6

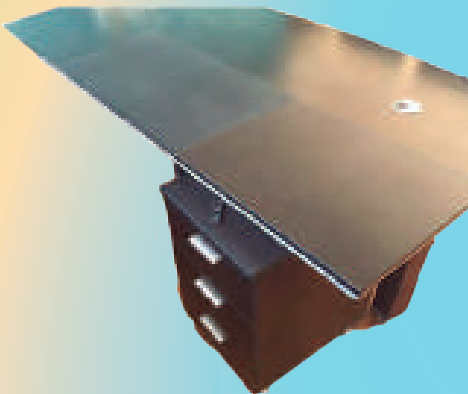

MODULO 7



MODELO 8



MODELO 9



MODELO 10



MODELO 11



MODELO 12



MODELO 12



MODELO 13



MODELO 14



MODELO 15



MODELO 16



MODELO 17



MODELO 18



MINKA 2 S-C



MINKA 2 CAJONERA

COUNTER DE RECEPCIÓN

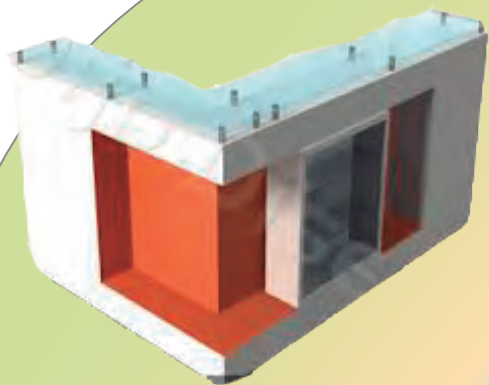

MODELO 1

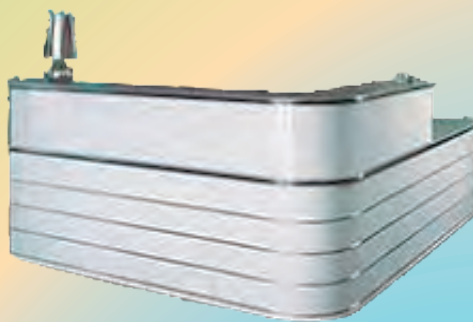

MODELO 2

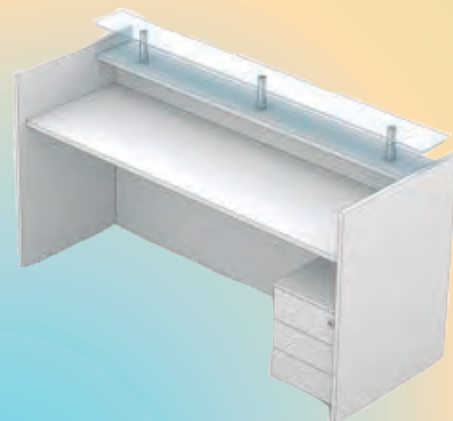

MODELO 3

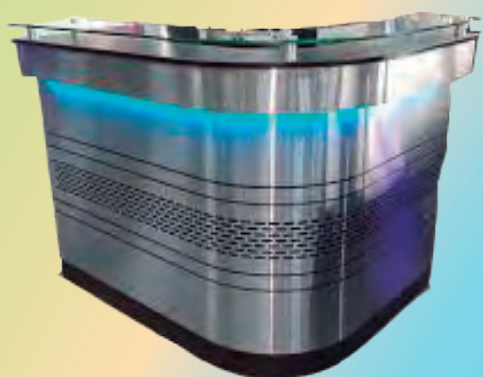

MODELO 4

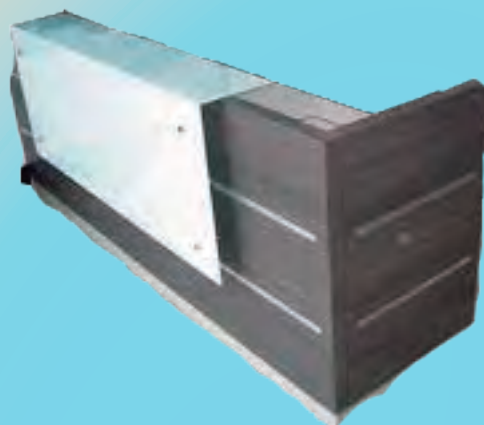

MODELO 5



MODELO 6

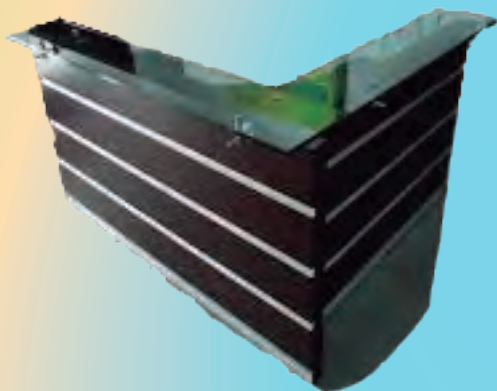

MODELO 7

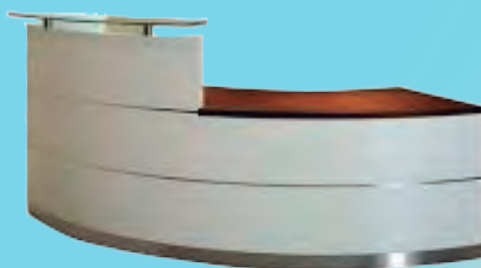

MODELO 8

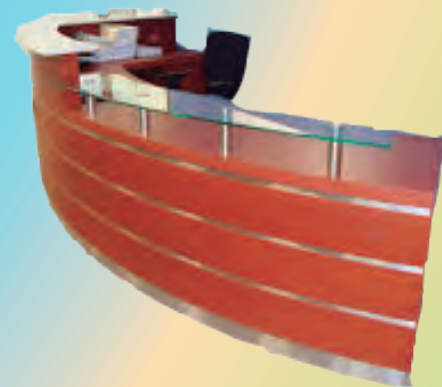

MODELO 9

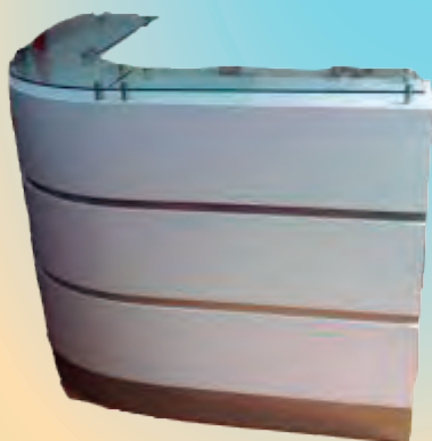

MODELO 10



MODELO 11



MODELO 12

COUNTER DE RECEPCIÓN



MODELO 13



MODELO 14



MODELO 15



MODELO 16



MODELO 17

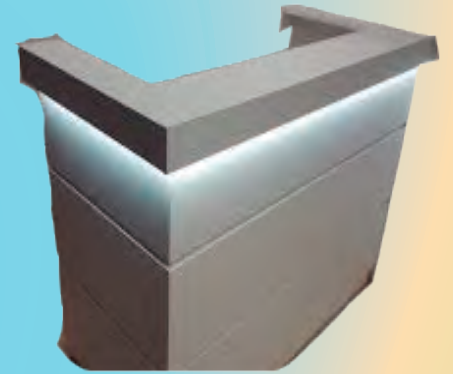

MODELO 18



MODELO 19

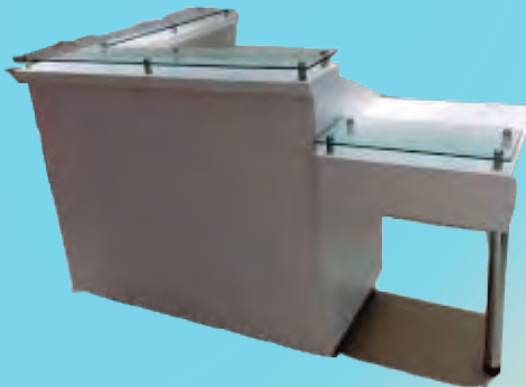

MODELO 20



MODELO 21



MODELO 22



MODELO 23

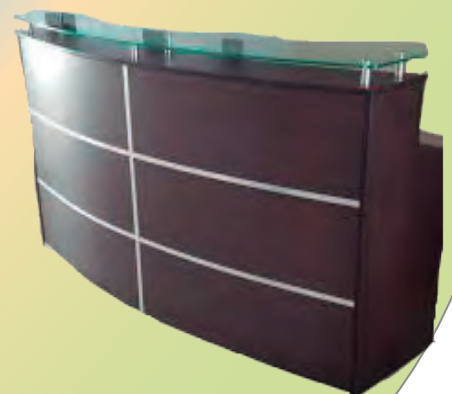

MODELO 24

COUNTER DE RECEPCIÓN



MODELO 25

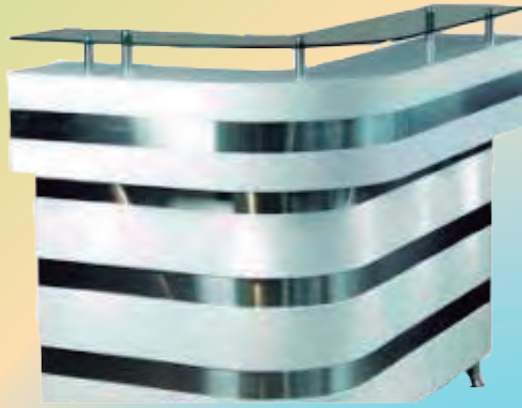

MODELO 26



MODELO 27



MODELO 28



MODELO 29

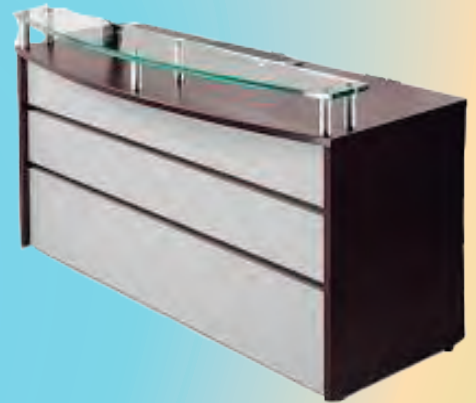

MODELO 30



MODELO 31



MODELO 32



MODELO 33



MODELO 34



MODELO 35

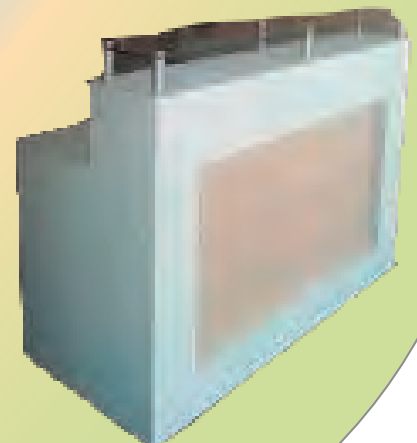

MODELO 36

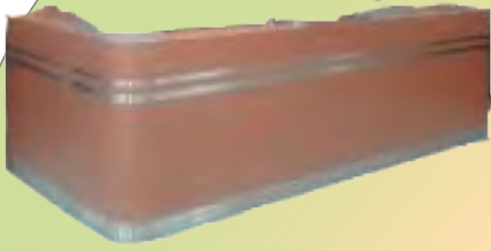

MODELO 37



MODELO 38

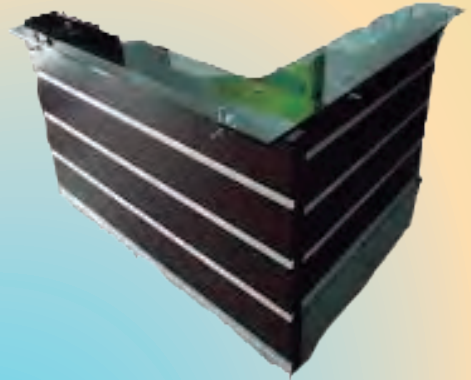

MODELO 39



MODELO 40



MODELO 41

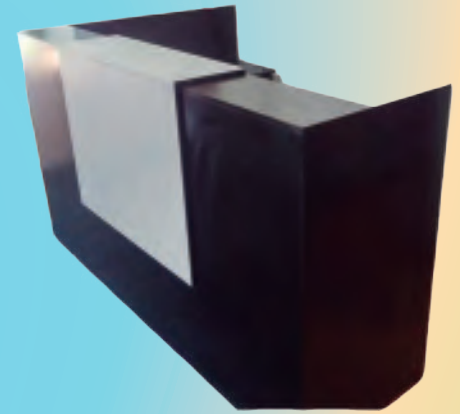

MODELO 42



MODELO 43



MODELO 44

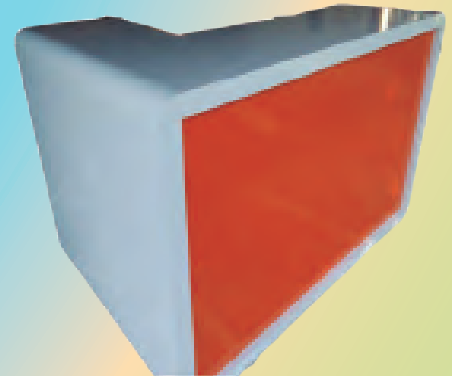

MODELO 45



MODELO 46

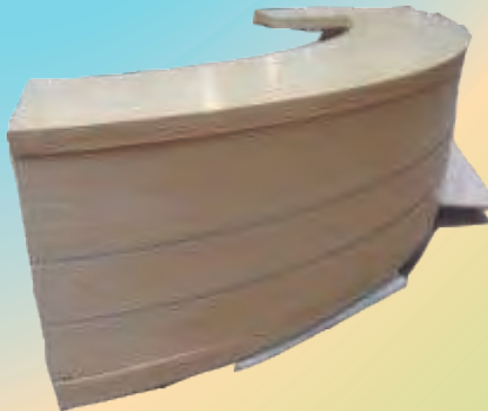

MODELO 47

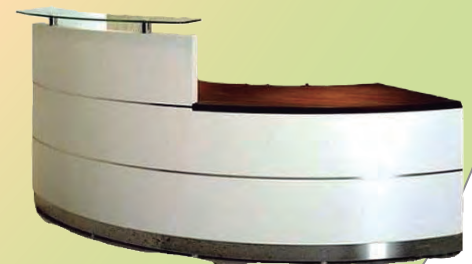

MODELO 48



MODELO 49

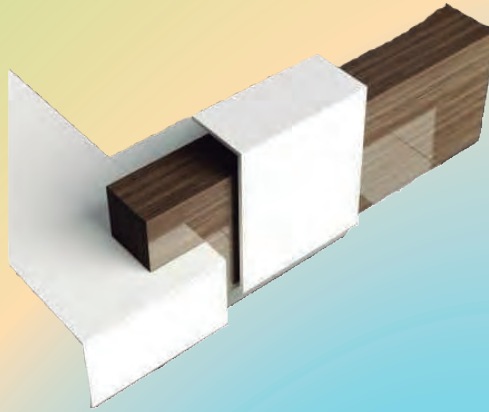

MODELO 50



MODELO 51



MODELO 52

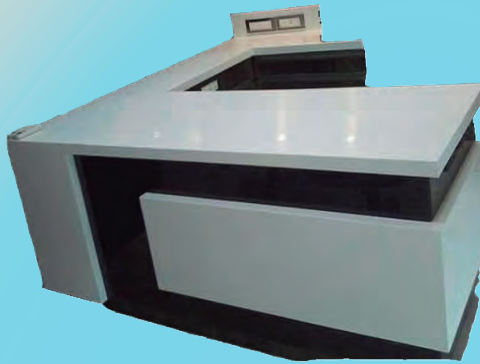

MODELO 53



MODELO 54



MODELO 55



MODELO 1



MODELO 2



MODELO 3



MODELO 4



MODELO 5



MODELO 6



MODELO 7



MODELO 8



MODELO 9



MODELO 10



MODELO 11



MODELO 12



MODELO 13



MODELO 14



MODELO 15



MODELO 16



MODELO 17



MODELO 18



MODELO 19



MODELO 20



MODELO 21



MODELO 22



MODELO 23



MODELO 24



MODELO 25



MODELO 26



MODELO 27



MODELO 28



MODELO 29



MODELO 30



MODELO 31



MODELO 32



MODELO 33



MODELO 34



MODELO 35

ESTACIONES DE TRABAJO



MODELO 1



MODELO 2



MODELO 3



MODELO 4



MODELO 5



MODELO 6



MODELO 7



MODELO 8



MODELO 9



MODELO 10



MODELO 11

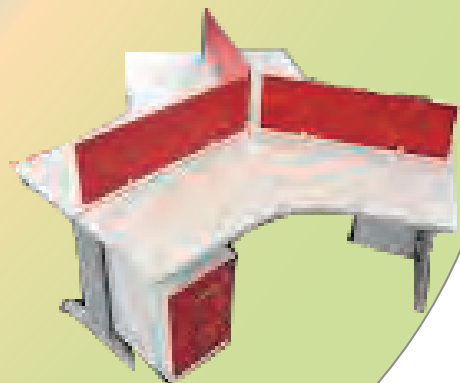

MODELO 12



MODELO 13



MODELO 14



MODELO 15



MODELO 16



MODELO 17



MODELO 18



MODELO 19



MODELO 20



MODELO 21



MODELO 22



MODELO 23



MODELO 24

ESTACIONES DE TRABAJO



MODELO 25



MODELO 26



MODELO 27



MODELO 28



MODELO 29



MODELO 30



MODELO 31



MODELO 32



MODELO 33



MODELO 34



MODELO 35



MODELO 36

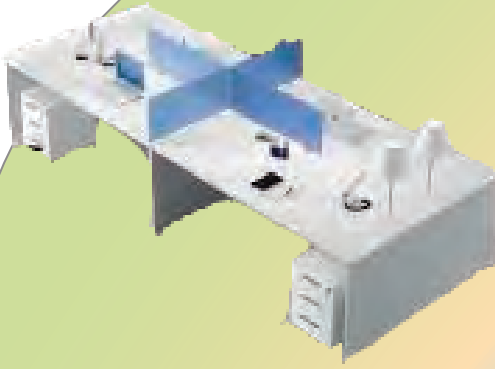

MODELO 37



MODELO 38



MODELO 39



MODELO 40



MODELO 41



MODELO 42



MODELO 43



MODELO 44



MODELO 45

MESAS DE REUNIONES



MODELO 1

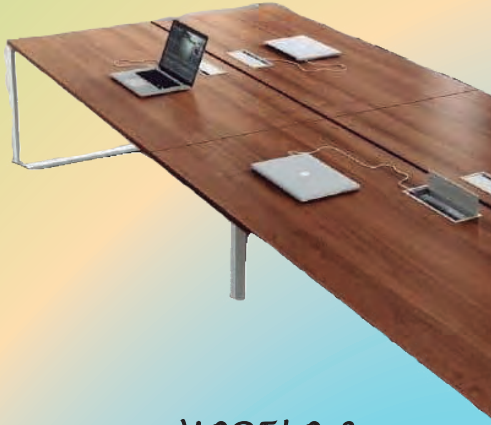

MODELO 2



MODELO 3



MODELO 4



MODELO 5



MODELO 6



MODELO 7



MODELO 8



MODELO 9



MODELO 10



MODELO 11



MODELO 12

MESAS DE REUNIONES



MODELO 13



MODELO 14

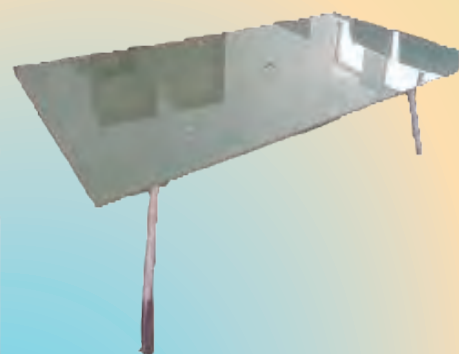

MODELO 15



MODELO 16



MODELO 17



MODELO 18



MODELO 19



MODELO 20



MODELO 21



MODELO 22

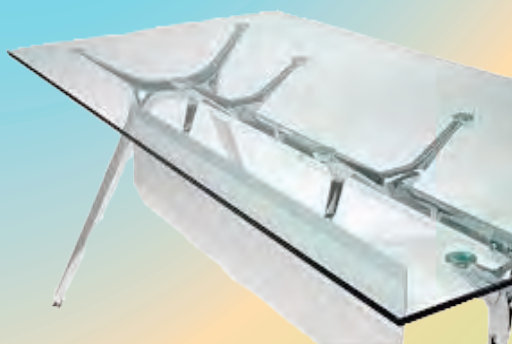

MODELO 23



MODELO 24



MESA REDONDA



MESA DE REUNIONES



MESA RECTANGULAR

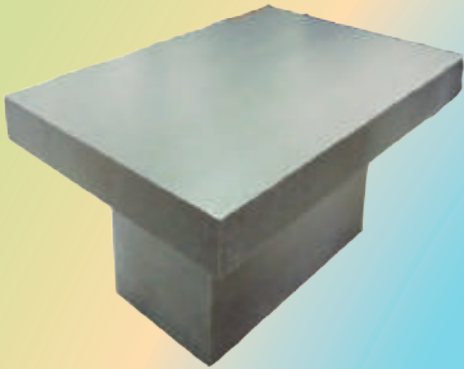

MESA CENTRO SALA

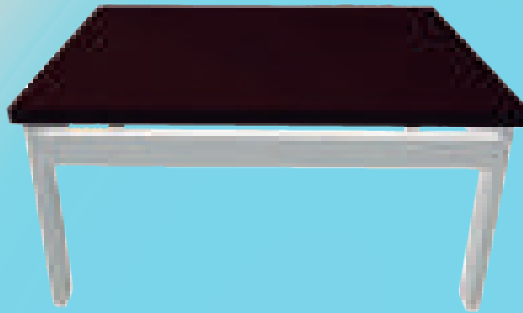

MESA CENTRO



ARCHIVADOR BAJO



ARCHIVADOR AEREO



CAJONERA MOVIL



ARMARIO BIBLIOTECA



SOFA UNIPERSONAL



GABINETE ALTO



GABINETE BAJO



ARCHIVADORES



ARMARIO BIBLIOTECA



ARTURITO



BOTIQUIN



CAMILLAS



ESTANTERIAS

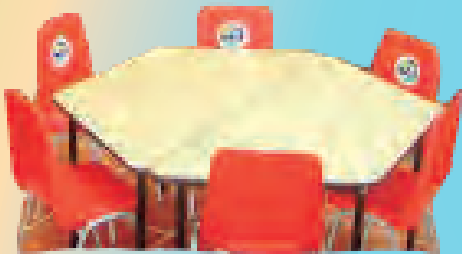

JUEGO MESA SILLA

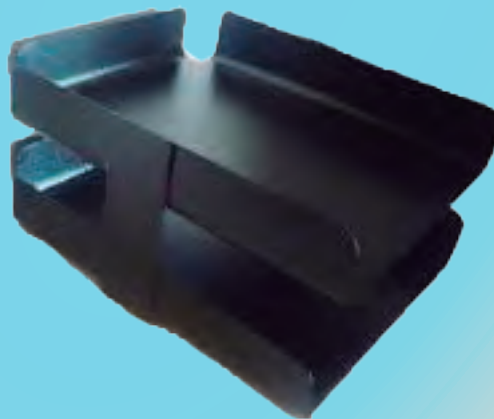

PAPELERAS (2-3)



PORTA CPU



ARCHIVADOR AEREO



MESA DE REUNIONES



SILLA DE ESPERA



omsacorpress

SOLUCIONES RÁPIDAS EN BIENES Y SERVICIOS

CATÁLOGO MELAMÍNICOS

MELAMÍNICOS



ÁLAMO



ALASKA

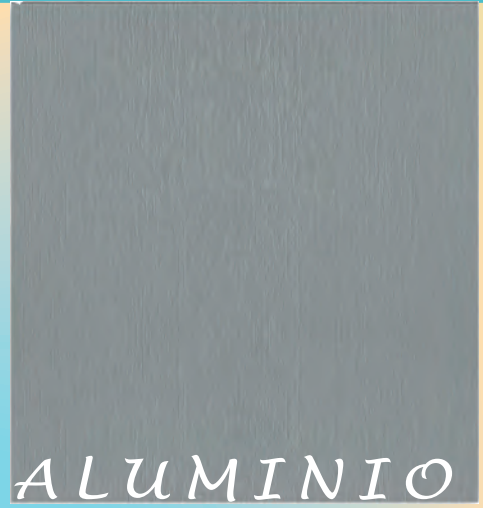

ALUMINIO



BLANCO



CANELA



CATANIA



CEDRO MERAK



CEREZO



CONGO



GRIS

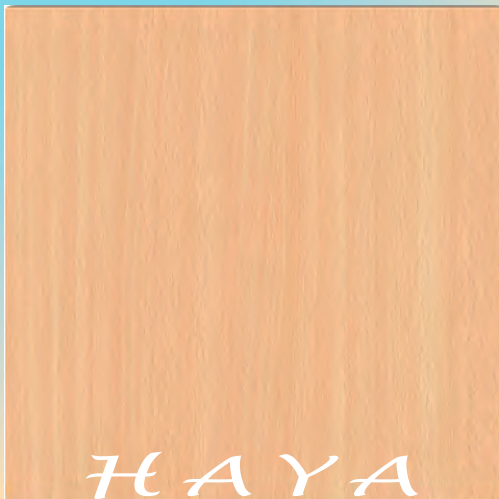

HAYA



LIENZO

MELAMÍNICOS



MOKACCINO



MOROCCO



MOSCADA

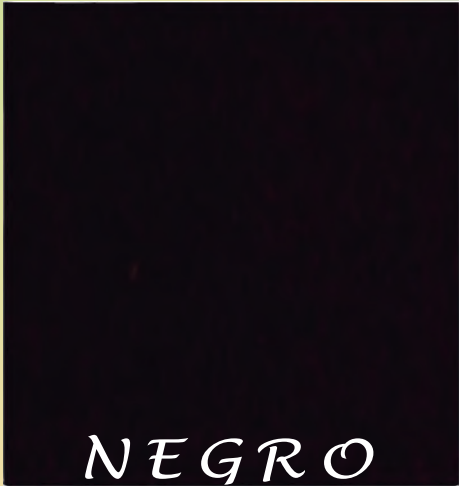

NEGRO



NOGAL MONDO



NOGAL PARIS



NUEZ



OLMO MANGATA



PORTOBELO



ROBLE MIEL



ROBLE NAZ



ROBLE VENEZIA

MELAMÍNICOS



SEPIA

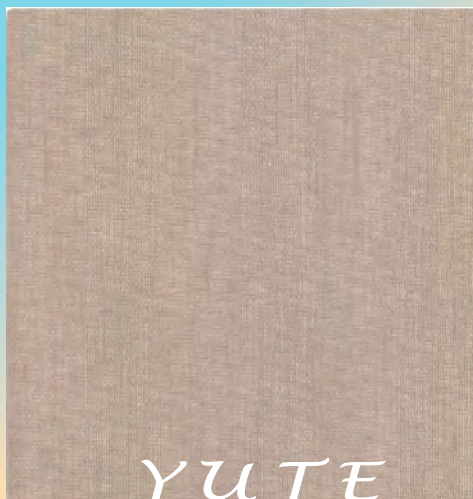

ALTO BRILLO

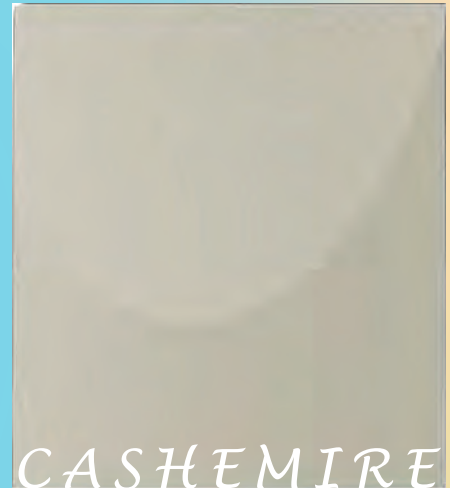

VESTO

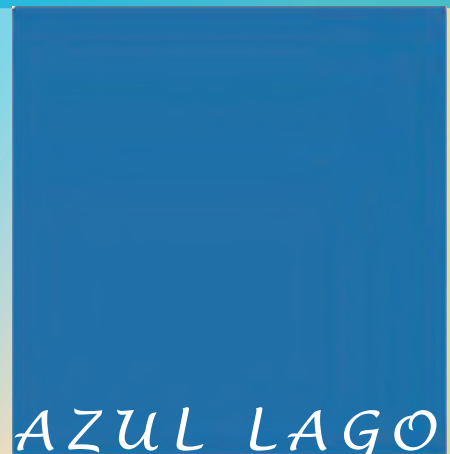

ULTRAMATE

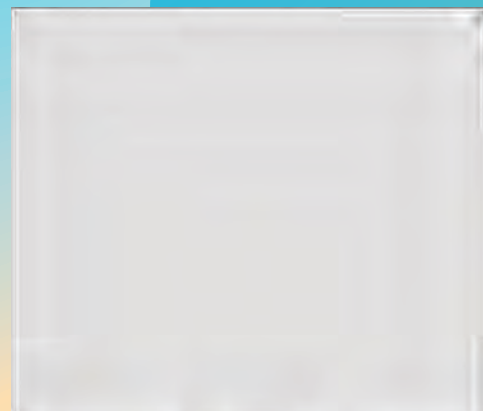

METALIZADO



ÓXIDO

SYNCRÓ



BAVIERA



SAVANA



ANIME



HAYA



ROBLE AMERICANO

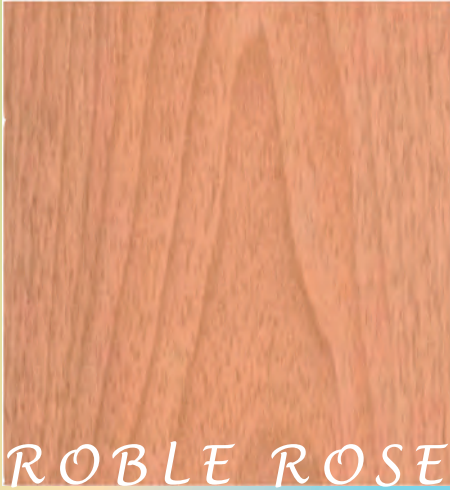

ROBLE ROSE



SEIKE



ROBLE MARFIL



LAUREL NENQUE



ILUSIÓN



ABSTRACTO



INSPIRA



ENSUEÑO



INFINITO



MÁGICO



FANTASÍA



EUFORIA

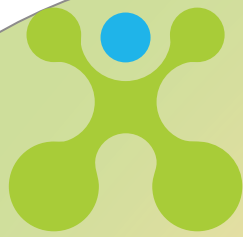

omsacorpress

SOLUCIONES RÁPIDAS EN BIENES Y SERVICIOS

CATÁLOGO FÓRMICAS



BERENJENA (2243BR)



BORGUNDY (2158MT)



RUBY (2135MT)



ROJO (2137BR)



TANGELLO (2239MT)



PINK (2273MT)



OLIVE (2248IT)



FOREST (2252)



TURQUESA (2176BR)



CARIBE (2182MT)



CITRUS (2205MT)



VERDE NEON (2186MT)

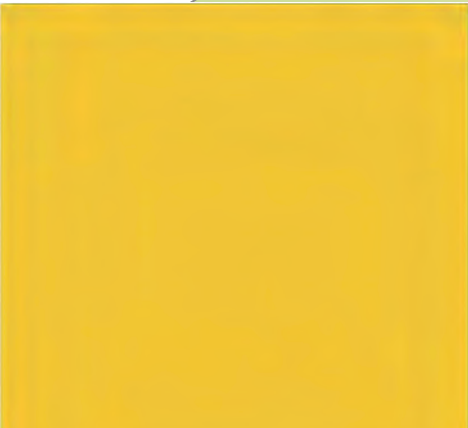

AMARILLO ORO (2152)



AZUL PACIFICO (2170MT)



LAPIZLASULI (0888MT)



MEDITERRANEO (2180MT)



MIST (2251XM)

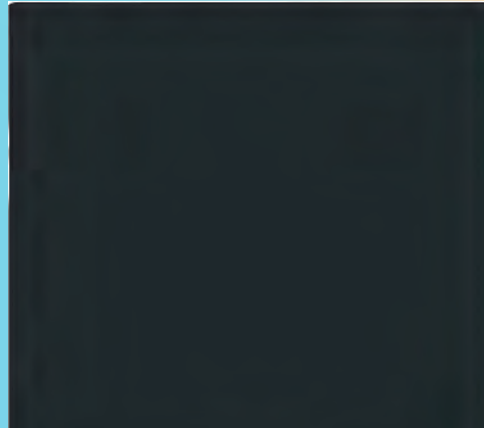

CARBÓN (2192MT)



TAUPE (2165MT)



ALUMINA (2103MT)



HUMO (2108MT)



MOUSE (2193MT)

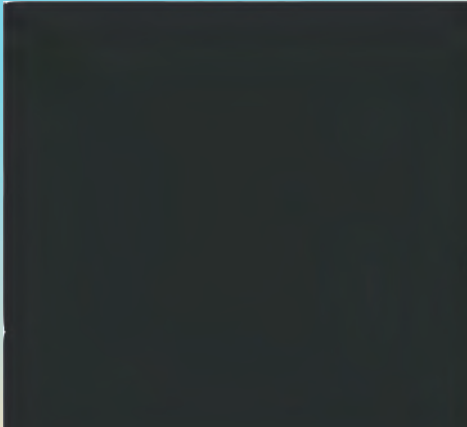

GRAFITO (2174MT)



GRIS NIEBLA (2191MT)



GRIS NUBLE (2189MT)



ALMENDRA (0920MT)



CHAMPAÑA (2107MT)



BLANCO (2112BR)



VAINILLA (2109MT)



BLANCO (2112MT)



NIEVE (2102BR)



NEGRO (2110BR)

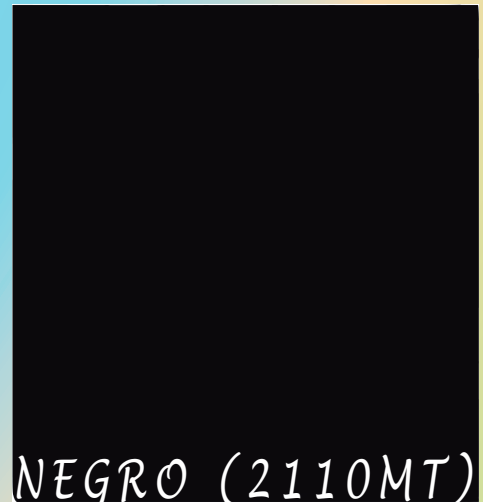

NEGRO (2110MT)

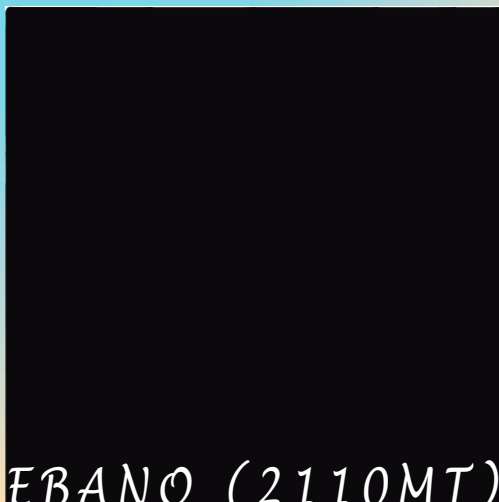

EBANO (2110MT)



OKUMEN (1535XM)



SEA WHITE (1502PR)



NATURAL ELM (1499MT)



NEUTRAL OAK (1498MT)

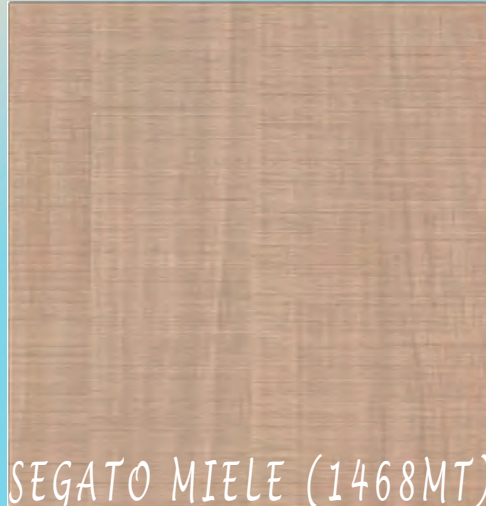

SEGATO MIELE (1468MT)



PERILLO (1320MT)



SEGATO LATTE (1469MT)

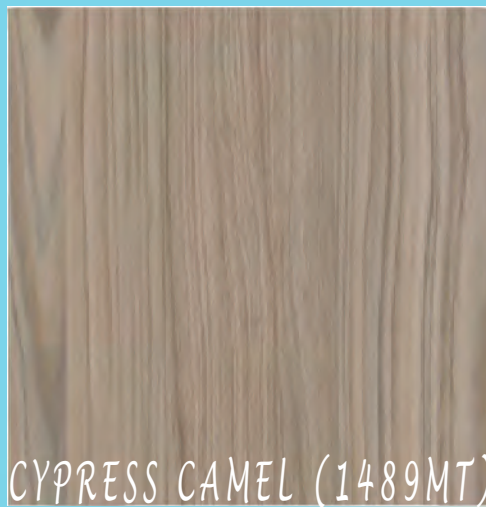

CYPRESS CAMEL (1489MT)



NOCE NATURALE (1534)

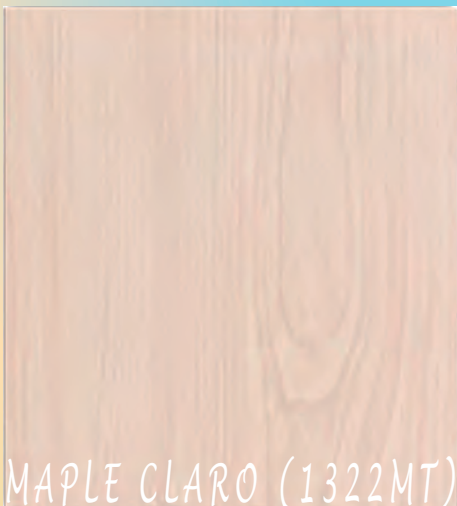

MAPLE CLARO (1322MT)

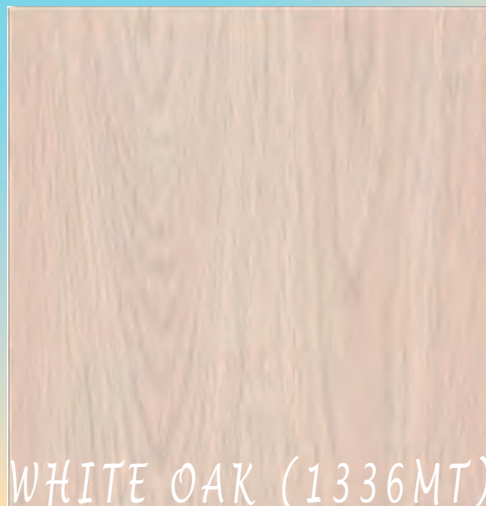

WHITE OAK (1336MT)



LARICE 3D (1461DL)



OLIVER ELM (1503PR)



CYPRESS CINNAMON (1490MT)



ROVERE FIUMO (1462MT)



FRENCH WALNUT (1510UP)

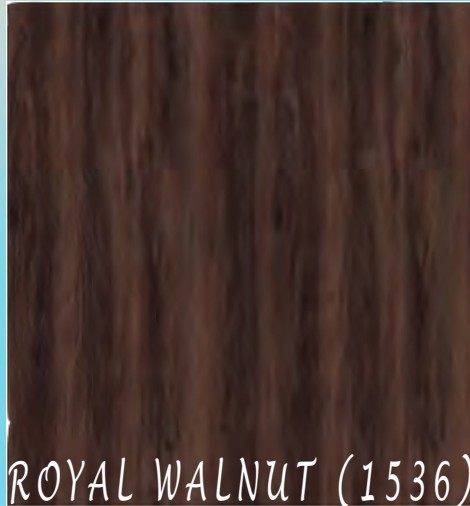

ROYAL WALNUT (1536)



GREY OAK (1829MT)



SAVAGE WALNUT (1537PR)



PROVENCE ASHEN (1515PR)



QUEENS (1934DL)



CAFÈ OAK (1830MT)



GREY CEDAR (1465MT)



BROWN OAK (1836MT)

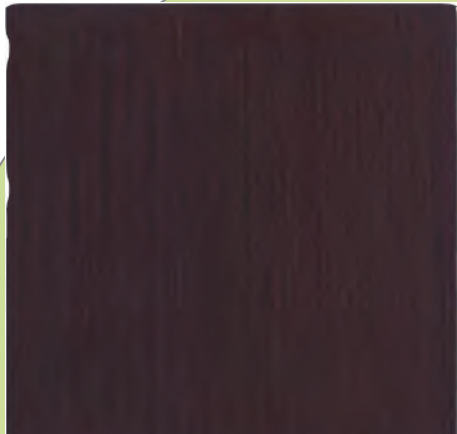

WENGUE (1807MT)

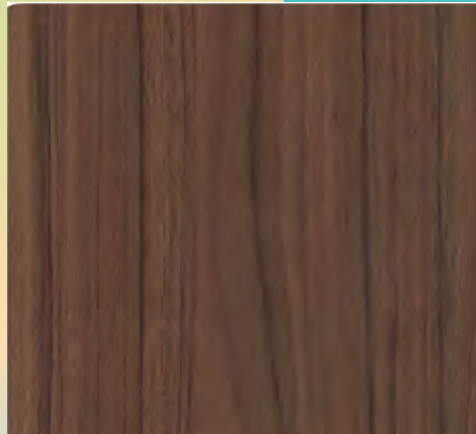

ITALIAN WALNUT (1513PR)

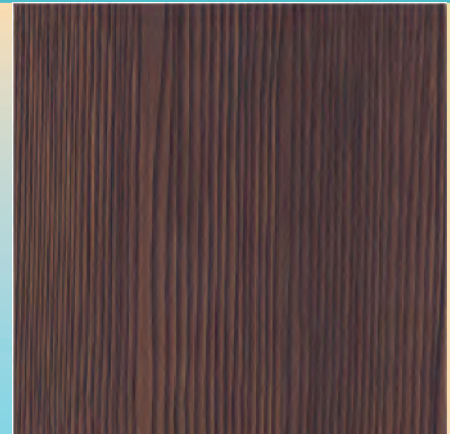

LARICE ESPRESS (1492MT)



CHOCOLATE OAK (1808MT)

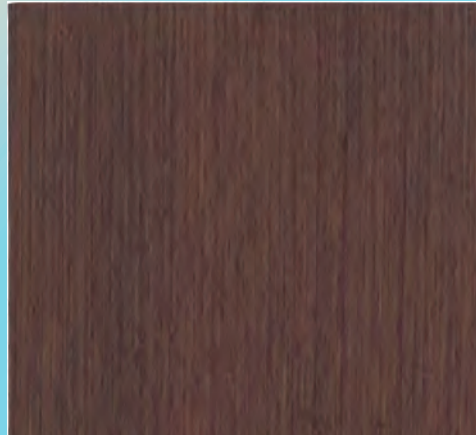

WENGUE TABACO (1834MT)

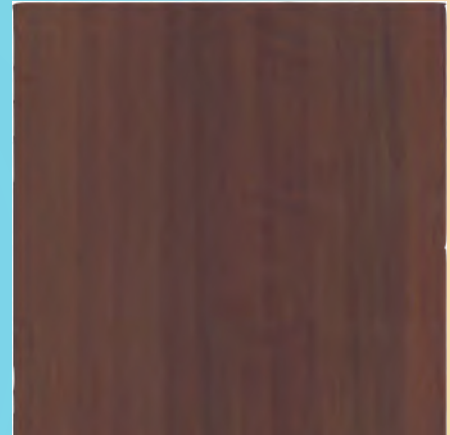

NOCE (1841MT)

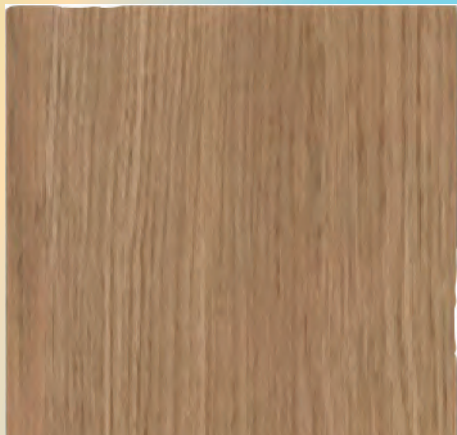

ROBLE LINEAL (1467MT)



SPICED CHESTNUT (1517PR)

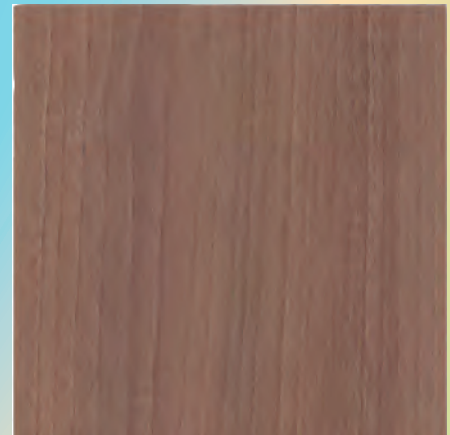

NOCE CAFFÈ LATTE (1832MT)

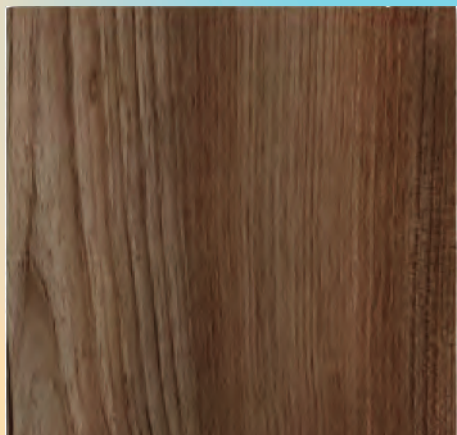

VINTAGE TEAK (1516PR)

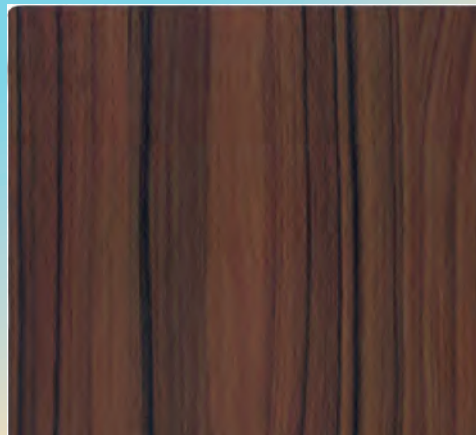

PALISANDER (1839MT)

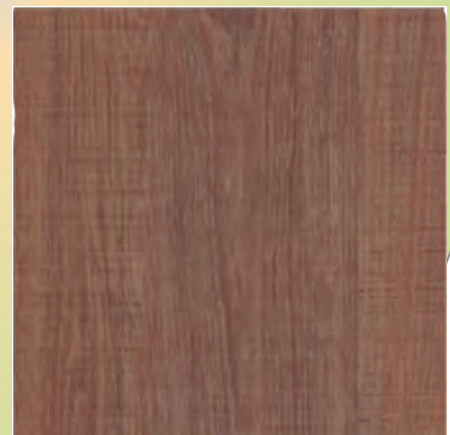

SERRA DORATO (1835MT)

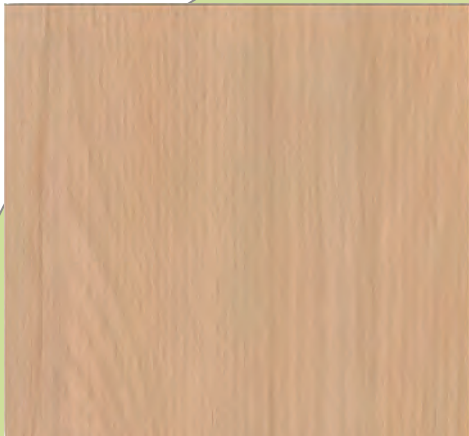

HAYA NATURAL (1803MT)

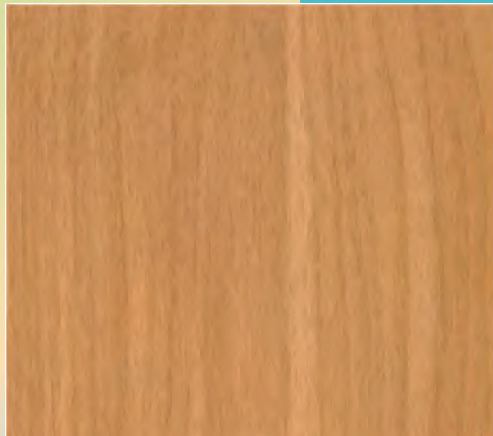

FRESNO (0470MT)

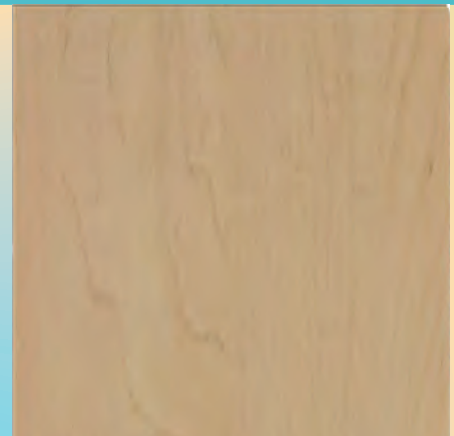

HARD ROCK MAPLE (0791MT)



ALPI CLARO (1799MT)

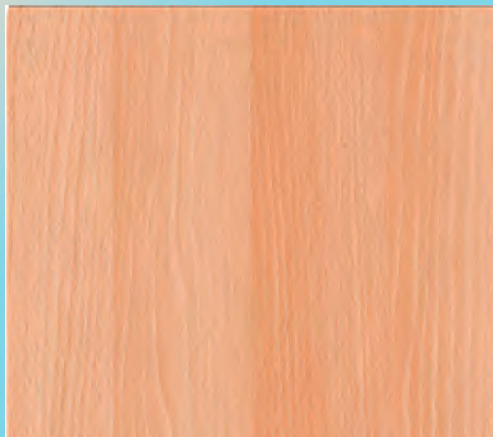

HAYA (1750MT)

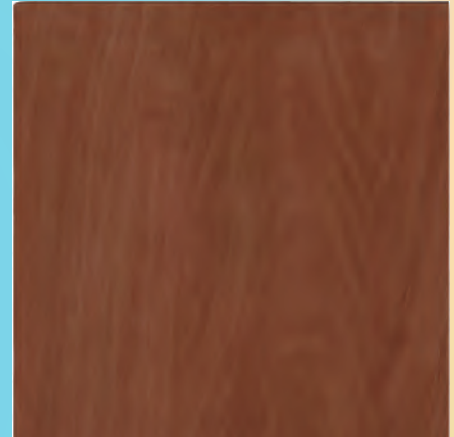

TAMARINDO (0506MT)

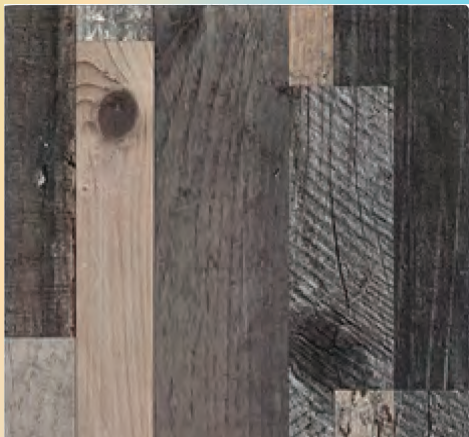

TIMBER BLOCKS (1521DL)

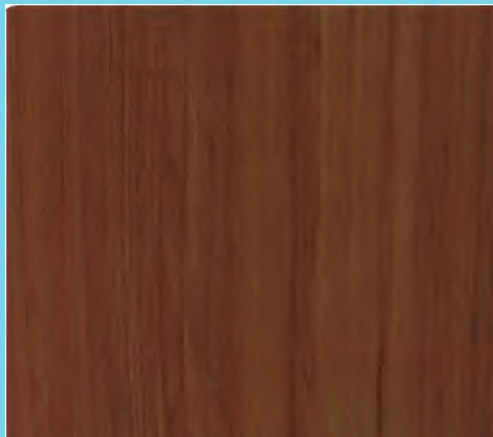

GRANADILLO (1740MT)

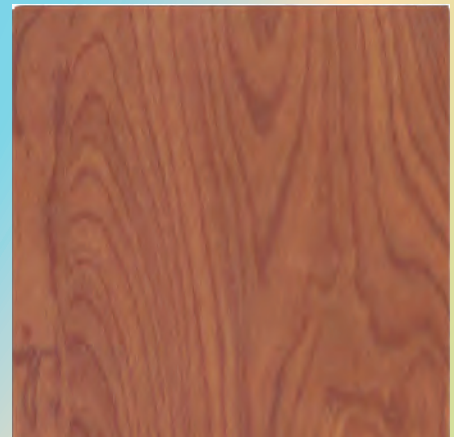

CEREZO AGRESTE (1473MT)

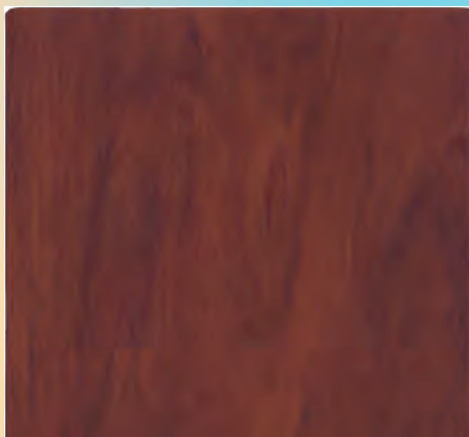

MAHOGANY (1460MT)

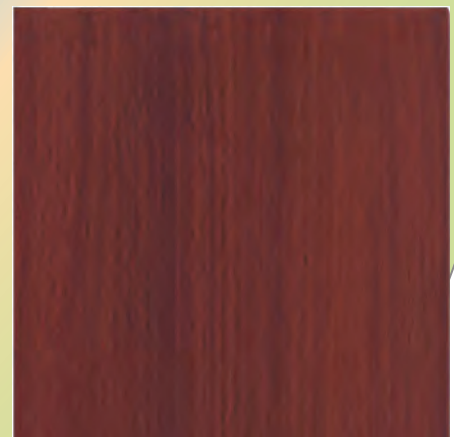

ZAPELLY CAOBA (0380MT)

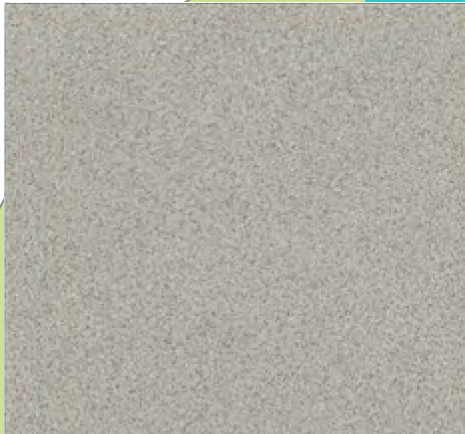

ASTRAL (3030MT)

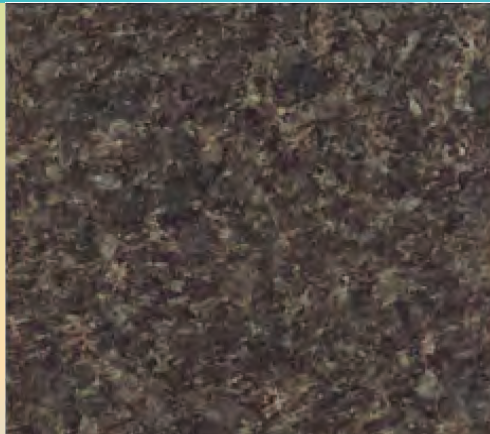

GRANITE CHOCOLATE (3034SP)



GRANITO METALIZADO (5030MT)



GALAXIA GRAFITO (0491MT)



HEAVY METAL (3152PL)



IMPERIALE (3157)



INDUSTRIAL CONCRETE (3127MT)

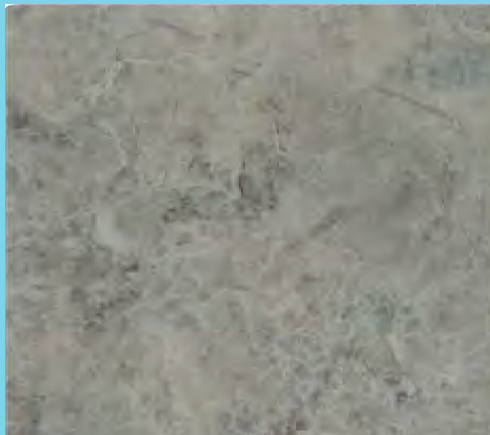

LATTE ITALIAN (2728SP)

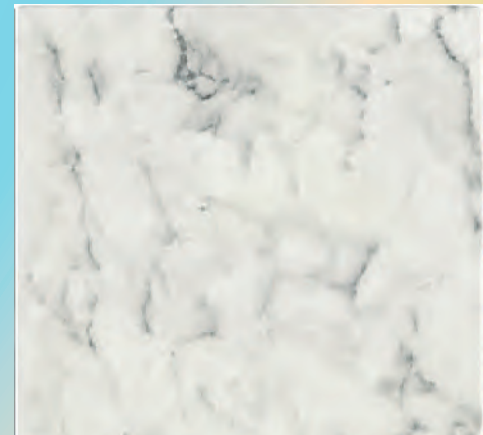

MARINA DI CARRARA (3151PL)

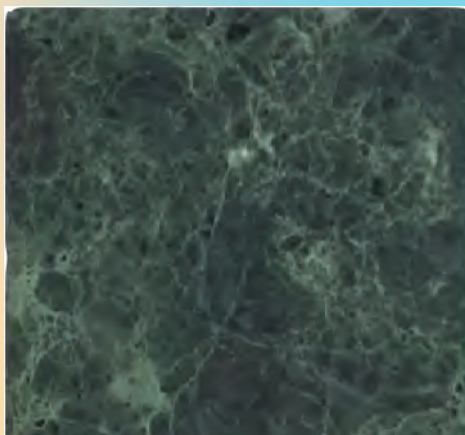

MÁRMOL FLORENTINO (0511BR)

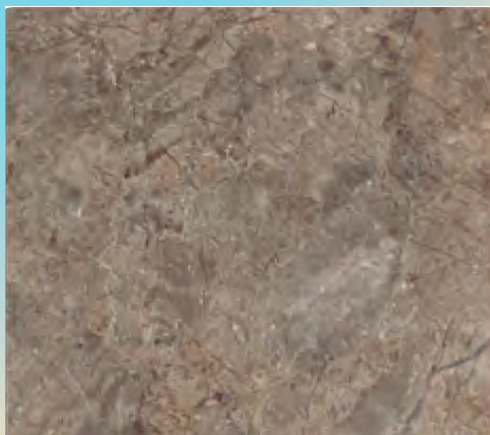

PIETRA ADOBE (2716MT)

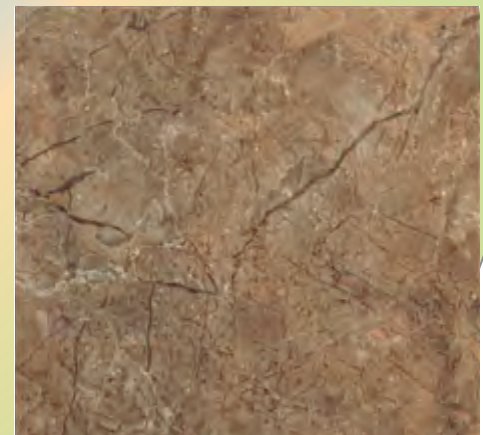

PIETRA AMBAR (2718MT)

MÁRMOLES, PIEDRAS Y CONCRETOS



RUSTIC OXIDE (3134MT)



SAND IMPERIAL (3108SP)

PIZARRAS



BLANCO NIEVE (2102MT)

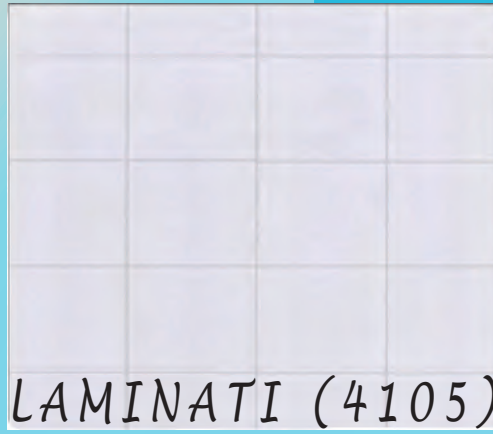

LAMINATI (4105)

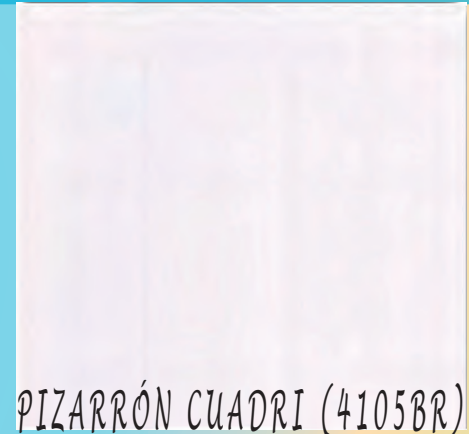

PIZARRÓN CUADRI (4105BR)

PERLESCENTES



PEARL (2512)



TANTALE CHAMP (2511)

METÁLICOS Y METALIZADOS

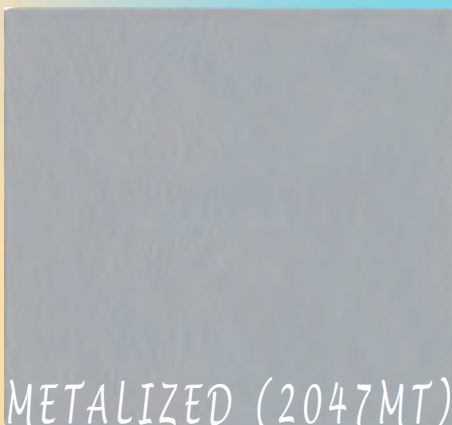

METALIZED (2047MT)

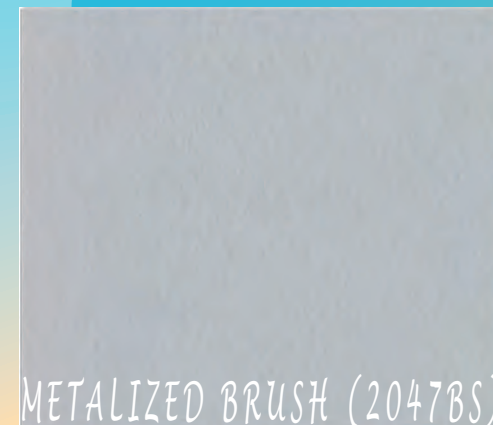

METALIZED BRUSH (2047BS)

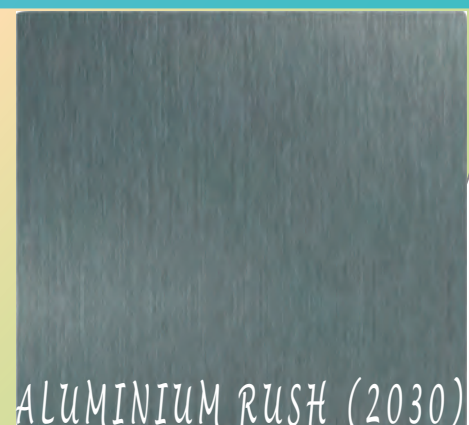

ALUMINIUM RUSH (2030)



omsacorpress

SOLUCIONES RÁPIDAS EN BIENES Y SERVICIOS

CATÁLOGO CANTO DURO



BLANCO



GRIS



LIENZO



METÁLICO



NEGRO



SEPIA



TITANIO



AZUL LAGO



ROJO



MARACUYA



ROBLE NAZ



ALASKA





SESAMO



NUEZ

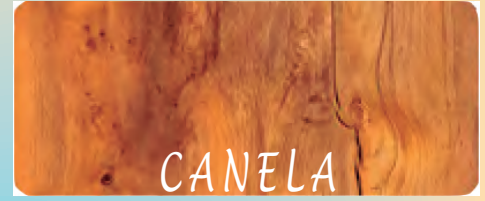

CANELA



NOGAL PARIS



PORTOBELO



WENGUE TABACO



WENGUE



TERRA



BAVIERA



OLMO MANGATA

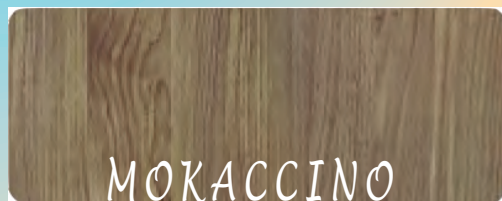

MOKACCINO

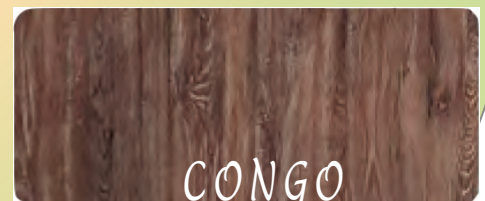

CONGO



ALTO BRILLO





ROBLE



HAYA



SAPELI



SEIKE



LAUREL NENQUE



ROBLE ROSE



ROBLE MARFIL



omsacorpress

SOLUCIONES RÁPIDAS EN BIENES Y SERVICIOS

CATÁLOGO SERVICIOS



Corte



Enchapado

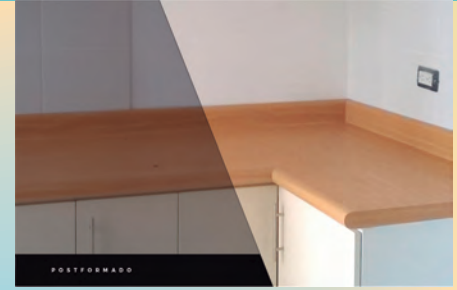

Postformado



Perforado



Pegado Fórmica



Ruteado Diseño



Retapizado

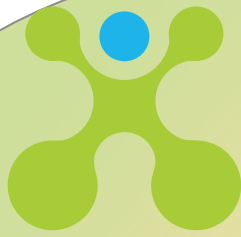

omsacorpress

SOLUCIONES RÁPIDAS EN BIENES Y SERVICIOS

Todos nuestros productos cuentan con el sello de:





omsacorpexpress

SOLUCIONES RÁPIDAS EN BIENES Y SERVICIOS

DIRECCIÓN: *Luis Rodríguez S9-107 Y Adrian Navarro*
TELÉFONO: +593 98-386-2316 / +593 96-782-1679
CORREO: *ventas@omsacorpexpress.com / info@omsacorpexpress.com*
www.omsacorpexpress.com
QUITO - ECUADOR